

frida baby

3-IN-1 HUMIDIFIER XL

+ DIFFUSER + NIGHTLIGHT

USER MANUAL





frida baby

3-IN-1 HUMIDIFIER XL

+ DIFFUSER + NIGHTLIGHT

NEVER MIST A BEAT

Put dry indoor air to bed with the 3-in-1 Humidifier XL + Diffuser + Nightlight. The extra-large tank keeps soothing, cool mist flowing for up to 60 hours so the whole fam can breathe and sleep easier. Plus, a convenient top-fill design and carrying handle make quick work of cleaning and refills. It's a mist-see marathon that won't leave a dry eye (or nose) in the house.

**MIST.
BREATHE.
SLEEP.
REPEAT.**



TABLE OF CONTENTS:

FEATURES + SPECIFICATIONS	6
WARNINGS	10
OPERATING INSTRUCTIONS	12
INFORMATION ON USE OF ESSENTIAL OILS	14
CARE + CLEANING	15

FEATURES:



60-HR COOL MIST – Ultrasonic vibrations turn water into a cool, hydrating mist for up to 60 hours.



EASY-TO-CLEAN WATER TANK – Wide mouth opening makes accessing the tank for cleaning easy. Cleaning brush included.



TOP FILL DESIGN – One hand holding baby? No problem. Just pour some water on the top lid to fill the water tank.



ESSENTIAL OIL DIFFUSER – Soothing vapors relieve discomfort and help bring on the Zzzs. Just add BreatheFrida Vapor Drops (sold separately) for instant aromatherapy.



NIGHTLIGHT – Set the mood with 3 brightness levels.



AUTO-STOP FEATURE – Designed to automatically turn off when the water runs out or the tank is removed.

SPECIFICATIONS:

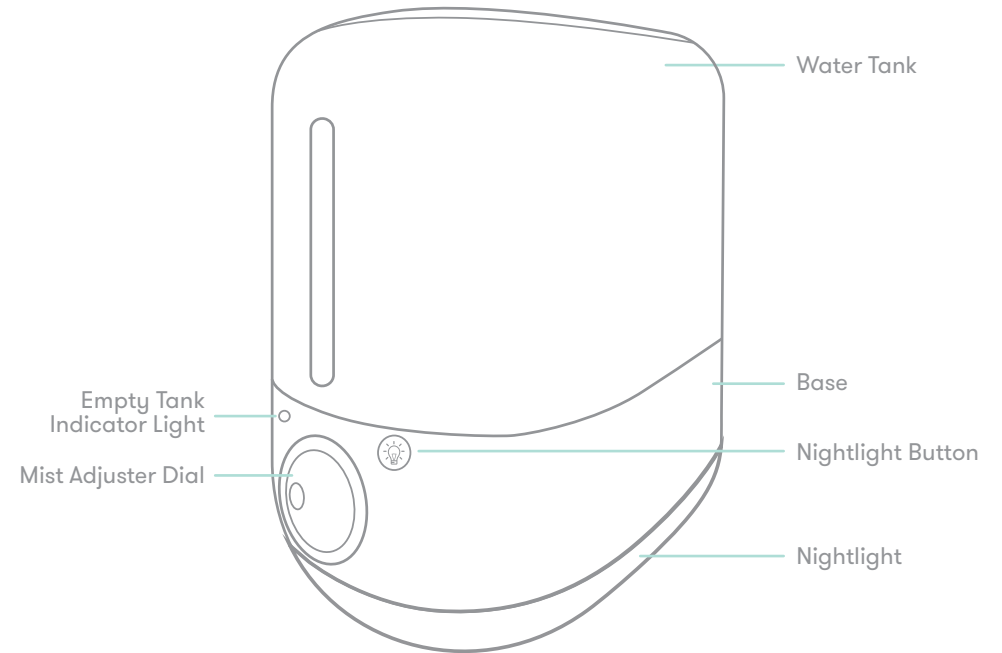

SPECIFICATIONS:

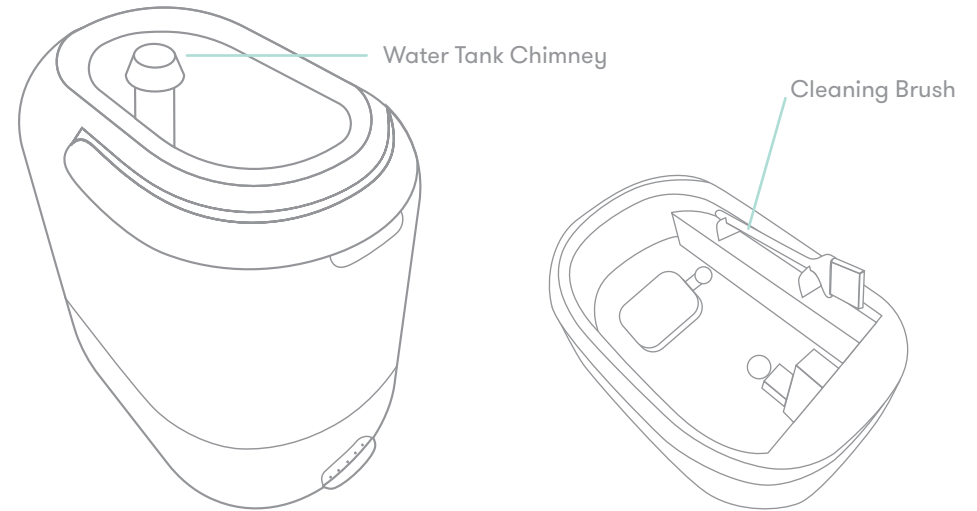
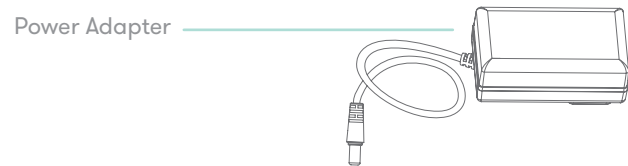
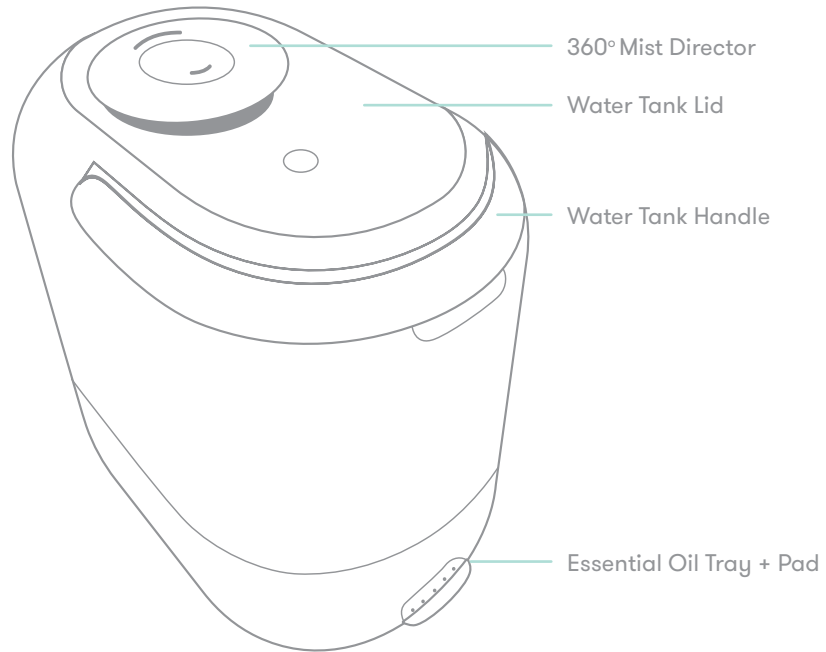

TECHNICAL DATA:

Product Name: 3-in-1 Humidifier XL + Diffuser + Nightlight
Model Number: 100001447
Power: 24V/1.5A
Dimensions: 296 × 301 × 204 mm
Conforms to UL STD, 998. Certified to CSA STD. C22.2 No. 104
Household use only



WARNINGS:

READ AND SAVE THESE INSTRUCTIONS

Failure to comply with the warnings below may result in electric shock or serious injury.

⚠ STRANGULATION HAZARD! - This device is not a toy. Keep out of reach of children. Do not use with extension cords. For adult use only.

This product should be used only in accordance with the specifications outlined in this manual. Usage other than what has been specified here may result in serious injury.

CAUTION:

- Disassembly, repair or remodeling by any unauthorized person may result in serious harm and will void the manufacturer's warranty.
- Always place the humidifier on a flat surface. It will not work properly on uneven surfaces.
- This product releases mist. Do not place this humidifier directly on wooden furniture, flooring or any surface that could be damaged by water. Fridababy LLC does not accept any liability for damage in the case of the unit being placed incorrectly.
- Do not use if the plug or power cord is damaged or loose. Discontinue use if any signs of deterioration appear on the unit or on the power cord.
- Arrange power cord to minimize the possibility of accidents.
- Do not use the power cord as a handle. Only plug in or remove the power cord by the plug head. Do not excessively bend, twist, pull or damage the power cord.
- Do not handle the plug with wet hands.
- Before filling or cleaning the unit, make sure the humidifier is unplugged.
- Once the humidifier has been plugged in, do not tilt or move the unit.
- Do not remove the water tank from the unit while it is on.
- Avoid placing this product where the mister is pointed directly at an object or person.
- Do not directly inhale the mist/vapor expelled from the product or drink water from the tank.
- Do not fill the water tank with hot or boiling water.
- Do not use this product in direct sunlight or near a heat source such as a stove, heater or radiator.
- Do not use if the water tank becomes cracked or damaged.
- Unplug the cord when unit is not in use for an extended period of time, and/or when no one is home.
- To avoid mold or mildew growth, empty the water tank between each use.
- Do not clean the unit, water tank or water reservoir with detergents or chemicals of any kind except as specified in these instructions.

- Do not fill water through the mister or oil tray.
- Do not fill water through mist outlet.
- Do not fill water through water outlet chimney.
- Do not use this product near any other electronic device.
- Do not cover the mister at any time during use.
- Do not put anything other than water in the water tank.
- Do not put anything other than essential oil in the essential oil tray.
- For household use only. Do not use outdoors.
- Do not tamper with humidifier in any way. If for any reason the unit fails to function properly, immediately return it to Fridababy LLC.
- This product is not intended for use by children or persons with limited physical and mental capabilities unless they have been instructed or supervised on the proper use of this product by a person responsible for their safety.

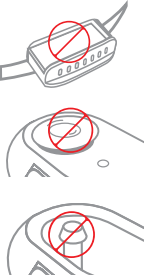

This device complies with part 15 of the FCC Rules. Operation is subject to the following two conditions: (1) This device may not cause harmful interference, and (2) this device must accept any interference received, including interference that may cause undesired operation.

NOTE: This equipment has been tested and found to comply with the limits for a Class B digital device, pursuant to part 15 of the FCC Rules. These limits are designed to provide reasonable protection against harmful interference in a residential installation. This equipment generates, uses and can radiate radio frequency energy and, if not installed and used in accordance with the instructions, may cause harmful interference to radio communications. However, there is no guarantee that interference will not occur in a particular installation. If this equipment does cause harmful interference to radio or television reception, which can be determined by turning the equipment off and on, the user is encouraged to try to correct the interference by one or more of the following measures:

- Reorient or relocate the receiving antenna.
- Increase the separation between the equipment and receiver.
- Connect the equipment into an outlet on a circuit different from that to which the receiver is connected.
- Consult the dealer or an experienced radio/TV technician for help.

WARNING: Changes or modifications not expressly approved by Fridababy, LLC could void the user's authority to operate the equipment.

OPERATING INSTRUCTIONS:

SETUP

- Turn mist adjuster dial to OFF
- Set the humidifier on a stable flat surface
- Plug wall adapter into wall socket
- Plug barrel connector into humidifier



FILLING

- For rapid filling
- Raise tank handle and lift water tank off of the base and bring water tank to water source
- Remove water tank lid

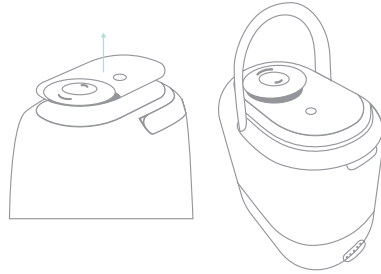

- Fill the water tank up to the fill line. Distilled water is best
- Place water tank lid back onto water tank. Lid should sit flush
- Place water tank back on base

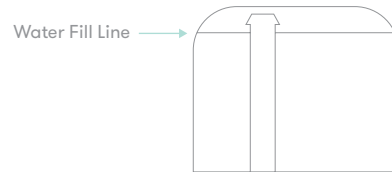

TANK TOP-OFF

- Tip for one-handers: The lid is recessed like a little tub. You can pour water onto the lid to refill the tank while the humidifier is on.

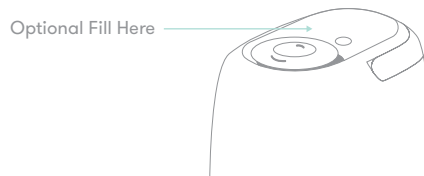

HUMIDIFIER OPERATION

- To turn humidifier on, turn mist adjuster dial clockwise to desired mist level
- To adjust mist direction, there are mist spouts on the water tank lid. You can turn the 360 mist adjuster to your desired direction. Try to point them away from nearby walls and furniture.
- To turn humidifier off, turn mist adjuster dial counter-clockwise to OFF
- When water runs out, the empty tank indicator light will illuminate and the humidifier will shut off automatically

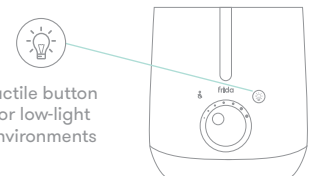
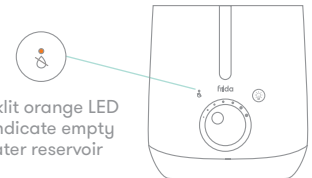
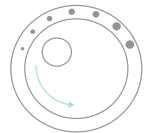
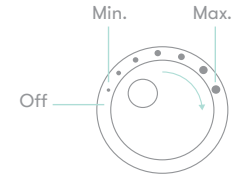

NIGHT LIGHT OPERATION

- Tap the night light button to turn on the night light
- 1 press turns on lowest brightness
- 2 presses medium brightness
- 3 presses highest brightness
- 4 presses turns night light off

ESSENTIAL OIL DIFFUSER

- The humidifier has a built-in diffuser so you can add your favorite essential oils to mist into the air.
- Pull out the essential oil tray to open.
- Add a few drops of essential oil to the essential oil pad.
- Push essential oil tray back into base.
- The essential oil pads can be used multiple times before discarding. Once discolored, dispose of pad and replace with new, clean pad.

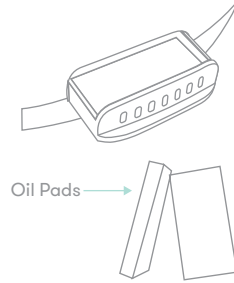

INFORMATION ON USE OF ESSENTIAL OILS:

Using essential oils is a great way to enhance the humidifier's effects. Be sure to follow our recommendations on how to use essential oils with your humidifier. Failure to do so may result in malfunction or damage to the humidifier or even harm to the user.

- Add drops of BreatheFrida Vapor Drops (sold separately) or other aromatherapy-grade essential oils onto oil pad.
- Only use essential oils with adult supervision. Do not allow children to use essential oils unsupervised.
- Wash the water chimney thoroughly after each use to remove residue.
- The water tank is made of oil-proof materials. Other parts may be damaged by direct contact with oil. Do not spill oil outside the water tank.
- Do not apply undiluted oil directly onto your skin or swallow it.
- If oil comes in direct contact with your skin, wash it off with water. If swallowed, seek medical help immediately. Keep oils away from eyes. If oils come in contact with eyes, wash eyes immediately with water. Consult a doctor, should irritation persist.
- If you feel unwell while using the product, turn off the device immediately.
- Pregnant women, elderly people, young children or people with chronic diseases may be more sensitive to scent. If they feel unwell, stop using immediately.
- Store essential oils in a dark cool place with the cap tightly closed and out of reach of children and pets.
- Use essential oils with a valid expiration date.

CARE + CLEANING:

CAUTION: Do not put into the dishwasher.

- Turn mist adjuster dial to OFF.
- Unplug the humidifier.
- Remove the lid.
- Twist off the water tank chimney.
- Remove the water tank from the base.
- Fill the water tank with warm soapy water (or use a damp cloth or nonabrasive sponge) and gently scrub the inside and outside of the water tank.
- Empty and rinse to remove all residue of the soap.
- With the water tank off the base, pour any residual water out of the base in the direction of the denoted arrow on the base.
- Use a damp cloth and mild soap to clean the inside of the base.
- Use the provided cleaning brush to clean corners that are hard to access with a cloth.
- Rinse base with water to remove any soap residue.
- Let the humidifier base fully air dry for at least 1 day.
- Twist water tank chimney back onto water tank.

NOTE: Do not leave water in the tank or base for an extended period of time, as this can encourage mold growth. Replace tank and base with fresh water daily.

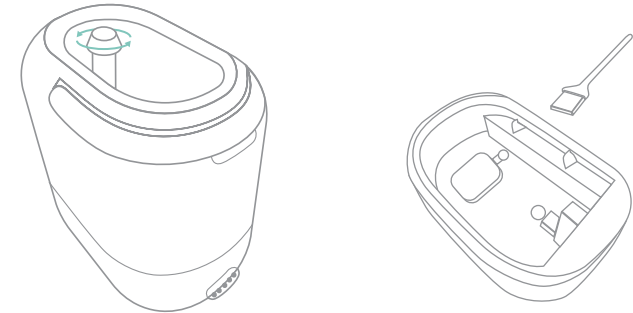

HOW TO DESCALE: Hard water buildup is a fact of life, especially if you use tap water. Just pour 3 cups of distilled white vinegar into the tank and let it sit for at least 15 minutes. Then pour the vinegar out and rinse the tank well. Scrub anything that resists. Make sure everything is dry before you pack the humidifier in storage.

BREATHE EAZZY.

YOU JUST FINISHED READING THE MANUAL.

Humidifier Questions?
frida.com/help

Manufactured for
(EU/UK Producer):
Fridababy LLC
82 NE 26th St
Miami, Florida, 33137
USA

EU Importer:
Nasalprodukter Sverige AB
S:t Johannesgatan 2
211 46 Malmö
Sweden

UK Importer:
MedEnvoy UK Limited
85, Great Portland Street,
First Floor
London, W1W 7LT
United Kingdom

Australia Distributor:
The Amazing Baby Company
11 Maurice Court
Nunawading, VIC 3131
info@tabc.com.au

Made in China

FRIDABABY, FRIDA and all trademarks mentioned herein are the registered and
unregistered trademarks of Fridababy, LLC © Fridababy, LLC 2023

frida baby